

ANALYSIS OF THERMAL AND GAS-DYNAMIC CHARACTERISTICS OF DIFFERENT TYPES OF PROPELLANT IN SMALL WEAPONS

by

**Walid BOUKERA ABACI^a, Nebojsa P. HRISTOV^{a*}, Nabil ZIANE AHMED^a,
Damir D. JERKOVIC^a, and Slobodan R. SAVIĆ^b**

^a Military Academy, University of Defense in Belgrade, Belgrade, Serbia

^b Faculty of Engineering, University of Kragujevac, Kragujevac, Serbia

Original scientific paper

<https://doi.org/10.2298/TSCI200814138B>

This paper presents a numerical and an analytical approach for calculation of internal ballistics parameters through determination of thermal and gasdynamic characteristics. The calculated parameters are validated through experimental tests on a real weapon system. The internal ballistic calculations are provided for two types of propellants using an analytical and a numerical model. Calculations and tests are performed for an anti-material rifle 12.7 mm. Weapon and ammunition testing is carried out according to the permanent international commission standard. Theoretical and experimental results for the gunpowder gases pressure and the muzzle velocity are compared. The good agreements between the calculated and the measured pressures and velocities increase the reliability of the estimated gunpowder gas temperatures in the barrel. The obtained results enable analysis and comparison of the output internal ballistics parameters for different types of propellant applications.

Key words: *internal ballistic, two-phase flow, experimental measurement, anti-material rifle, muzzle velocity, gunpowder gases pressure, gunpowder gases temperature*

Introduction

Gun firing is a complex thermodynamic process accompanied by great changes in pressure and temperature gradients and lasts from 0.5-5 ms. Pressure intensities of the combustion products vary from the value of atmospheric pressure to 400 MPa for a specific time interval. In addition the gas-dynamic stresses, the gun barrel is also exposed to high thermal stresses. The temperature of the propellant gas reaches several thousand degrees of Kelvin. Which makes the firing process difficult to describe using a mathematical model.

Akçay [1] solved the interior ballistic prediction method based on Resal equation by means of Runge Kutta method for the spherical and perforated propellants. He determined the values of pressures and temperatures for the 7.62 mm rifles for both internal and transitional ballistic periods. Jaramaz *et al.* [2], developed a two-phase flow internal ballistics model, they included a stable fast-converging numerical scheme to their computer code two-phase interior ballistics for solving discretization equations for the developed model. Bougamra *et al.* [3] predicted the muzzle velocity of the projectile, and the pressure history in the system during the firing process using 1-D, single phase, lumped-parameter models and multidimensional

* Corresponding author, e-mail: nebojsahristov@gmail.com

multi-phase flow model. Senturk *et al.* [4] investigated the interior ballistics problem using experimental, numerical and analytical methods with a thermo-mechanical approach. They employed the Valliere Heydenreich method to determine the transient pressure distribution along the barrel and the Noble-Abel equation calculate the gas temperature. Rezgui *et al.* [5] by using a developed 1-D interior ballistic code and CFD simulation in FLUENT modeled a two-phase flow of propellant combustion products and unburned propellant grains in the vented vessel and the heat transfer to the nozzle. Jevtić *et al.* [6] carried out numerical simulations to analyze the thermodynamic change of the gas properties in the gun's gas cylinder and the gas piston. The research shows comparison between the thermodynamic parameters results obtained by the CFD numerical simulations and experimental tests. Corner [7] studied the field of the interior ballistics, he summarized the theories of the burning of the gun propellant, he investigated the effect of the gunpowder grain geometries on the burning rate. The 1-D codes and multi-phase flow model codes for interior ballistics were summarized in [3, 8].

During the firing process, the barrel is subjected to both mechanical and thermal stresses. The gas temperature increases rapidly and heat is transferred into the barrel. The maximum bore surface temperature highly affects the wear and erosion of the barrel [9]. Lawton [10] showed that a 10% reduction in temperature reduced wear by about 300%. Calculations of pressures and temperatures during the firing process is essential for the weapon system design and optimization process.

This paper presents an analytical and a numerical model of internal ballistics calculations for anti-material rifle 12.7 mm. Calculations are made for two types of gunpowder: nitrocellulose seven-channel cylindrical (type C) and spherical propellant (type S). The results are compared with the measured values of experimental tests on the real model. Besides the classical internal ballistics parameters, the gas temperature change is calculated using the analytical and the numerical model for both propellants.

Mathematical models

To determine the relation between the gunpowder pressure and the projectile position in the barrel, the appropriate dependence between the characteristics of the barrel, the projectile and the propellant must be defined. The primary task of internal ballistic science is to provide the appropriate mathematical model to describe that dependence. Two mathematical models are used for this study.

Analytical model: Drozdov

The classical theory of internal ballistics was introduced by Drozdov, see [11]. The Drozdov method expresses the internal ballistic parameters as a function of one independent variable. The choice of the adequate variables is made so that its initial and final conditions are known. In this study, the independent variable is the relative thickness of the burned grain in the first period, and the projectile position in the second period. The first period start when the projectile begins to move and ends with the combustion of all the propellant grains. The second period starts right after the previous one and ends when the bullet exits the barrel. The following equations represent the equation system of internal ballistics that needs to be solved by the Drozdov method.

Equation of energy balance:

$$pS_C (X_\psi + X) = f_b m_b \psi - \frac{k-1}{2} \phi m v^2 \quad (1)$$

Equation of motion:

$$\varphi m \frac{dv}{dt} = p S_C \quad (2)$$

Projectile velocity:

$$v = \frac{dX}{dt} \quad (3)$$

Burning rate equation:

$$u_z = u_{z0} P \quad (4a)$$

with

$$\frac{dy}{dt} = \frac{u_{z0}}{r_0} p \quad (4b)$$

The burned propellant mass rate:

$$\psi = ky(1 + \lambda y + \mu y^2) \quad (5)$$

Grain surface burning rate:

$$\sigma = 1 + 2\lambda y + 3\mu y^2 \quad (6)$$

The approximate free volume length of the combustion chamber:

$$X_\psi = W_0 - \frac{m_b}{\rho_b} (1 - \psi) - \alpha m_b \psi \quad (7)$$

The baseline data for solving the system of equations are grouped as:

- Barrel characteristics: S_C , W_0 , and X_u .
- Projectile characteristics: m , p_0 , and φ .
- Propellant characteristics: m_b , f_b , α , u_{z0} , ρ_b , k , $2r_0$, k , λ , and μ .

According to Drozdov calculation method, the following assumptions are adopted:

- the propellant grains burn according to the geometric law hypothesis,
- the combustion takes place at medium pressure (although in reality it changes from the bottom of the gun to the bottom of the projectile),
- the combustion rate of the grain varies linearly with the pressure,
- composition of the combustion products during the firing process does not change, so that the specific work and co-volume are constant, and
- during the firing process, the resistance of the air, the deformations of the exterior bullet surface and the interior walls of the barrel are neglected.

Figure 1 represents the pressure, the velocity, and the position of the projectile as a function of time, calculated by the analytical Drozdov model for both propellants.

In order to calculate the temperature using the analytical model, the density of gases generated by the propellant combustion must be calculated using:

$$\rho = \frac{m_b \psi}{W_0 + S_C X - \frac{m_b (1 - \psi)}{\rho_b}} \quad (8)$$

Having determined the density of gases, we can calculate their temperature using the equation of state, the number of moles is calculated using the molar fraction, x_i , of the combustion products [12].

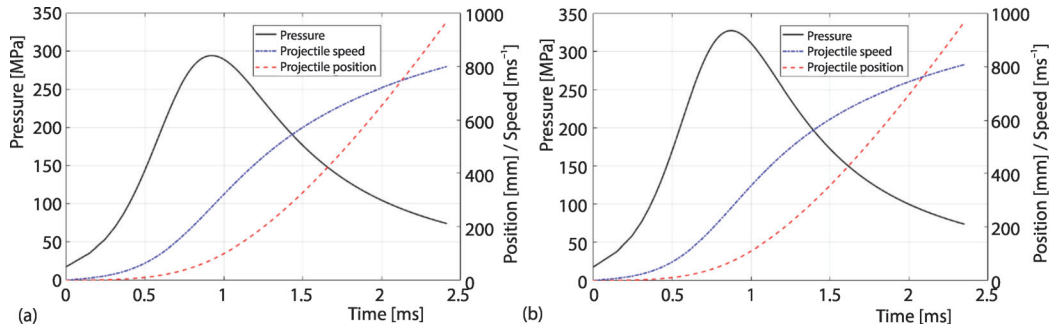

Figure 1. Pressure, velocity, and position of the projectile as a function of time; (a) C-type: NC cylindrical seven-perforated and (b) S-type: SB spherical

Equation of state:

$$T = \frac{p}{\rho \sum \frac{x_i}{M_i} R} \quad (9)$$

Figure 2(a) represents the gas temperature as a function of the firing process time. Figure 2(b) represents the gas temperature as a function of the projectile position inside the barrel.

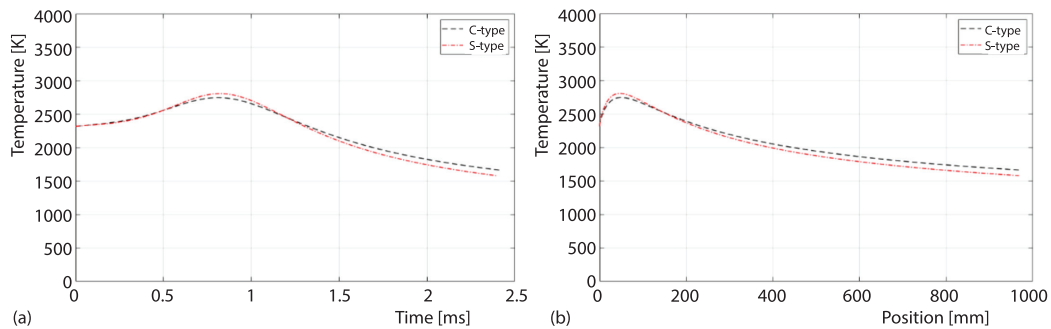

Figure 2. Temperature of gases during the firing process; (a) temperature vs. time and (b) temperature vs. position

Numerical model

For an accurate approach to the firing process inside the gun barrel, the model of internal ballistic calculation by the numerical method of a two-phase flow was developed, see [11] based on the energy, momentum and mass conservation equations. The two-phase flow method considers both the solid and the gaseous component, and at a given time compute different pressure values along the barrel.

To solve the described firing process numerically, it is necessary to adopt assumptions to solve the established equation system. The basic assumptions used are:

- the two-phase flow model is based on geometric law of gunpowder grain combustion,
- the shape of the propellant grain is well known,
- the mixture of gunpowder gases and grains is motionless and the pressure is uniform at all points before the movement of the projectile,
- the movement of the barrel is neglected,
- the gun cross-section area is the same along its entire length,

- the resistance of the air in front of the projectile is neglected,
- the energy loss due to heating the walls of the gun is not taken into account, and
- unburned gunpowder particles and gases move at different velocities.

Solution of the mathematical problem begins at the moment the projectile starts moving, and the initial conditions are determined based on the solution of the analytical model.

Figure 3 shows the volume division, W , (control volume) of length dx and the cross-section ($S = S_g + S_b$). The control volume is small compared to the total volume behind the projectile but it is large enough to receive a lot of gunpowder grains.

The gunpowder gases occupy the volume w_g so that:

$$W = W_b + W_g \quad (10)$$

Porosity is the ratio of the volume filled with gunpowder gases and the total volume:

$$\varepsilon = \frac{W_g}{W} \quad (11)$$

The mathematical model is described by a system of five PDE that connect gas-dynamic parameters, [13]:

The continuity equation for gases:

$$\frac{\partial}{\partial t}(\varepsilon\rho) + \frac{\partial}{\partial x}(\varepsilon\rho u) = (1-\varepsilon)\rho_b^2 \frac{u_z S_z}{m_z} \quad (12)$$

The continuity equation for gunpowder:

$$\frac{\partial \varepsilon}{\partial t} - \frac{\partial}{\partial x}[u_b(1-\varepsilon)] = \rho_b(1-\varepsilon) \frac{u_z S_z}{m_z} \quad (13)$$

The equation of gunpowder gases motion:

$$\frac{\partial}{\partial t}(\varepsilon\rho u) + \frac{\partial}{\partial x}(\varepsilon\rho u^2) + \varepsilon \frac{\partial p}{\partial x} = \rho_b^2 u_b(1-\varepsilon) \frac{u_z S_z}{m_z} - f \quad (14)$$

The equation of gunpowder grains motion:

$$\rho_b \frac{\partial}{\partial t}[u_b(1-\varepsilon)] + \rho_b \frac{\partial}{\partial x}[u_b^2(1-\varepsilon)] + (1-\varepsilon) \frac{\partial p}{\partial x} + \rho_b^2 u_b(1-\varepsilon) \frac{u_z S_z}{m_z} = f \quad (15)$$

The equation of the energy conservation:

$$\begin{aligned} \frac{\partial}{\partial t} \left[\varepsilon\rho \left(e + \frac{u^2}{2} \right) \right] + \frac{\partial}{\partial x} \left[\varepsilon\rho u \left(e + \frac{p}{\rho} + \frac{u^2}{2} \right) \right] + p \frac{\partial \varepsilon}{\partial t} + \rho_b(1-\varepsilon) \frac{q S_z}{m_z} = \\ = (1-\varepsilon)\rho_b^2 \frac{u_z S_z}{m_z} \left(e_b + \frac{p}{\rho_b} + \frac{u_b^2}{2} \right) - f u_b \end{aligned} \quad (16)$$

where

$$f = f^* \frac{1-\varepsilon}{2r_b} |u - u_b| (u - u_b) \rho \quad (17)$$

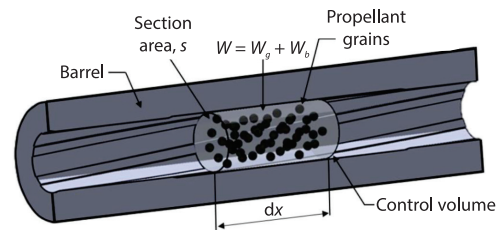

Figure 3. Control volume with gunpowder grains and gases [13]

and

$$f^* = \begin{cases} 1.75 & \varepsilon < \varepsilon_0 \\ 1.75 \left(\frac{1-\varepsilon}{1-\varepsilon_0} \frac{\varepsilon_0}{\varepsilon} \right)^{0.45} & \varepsilon_0 \leq \varepsilon \leq \varepsilon_1 \\ 0.3 & \varepsilon_1 < \varepsilon \leq 1 \end{cases} \quad (18)$$

The current system of equations contains two independent variables (x, t) and eleven dependent variables. The basic equations are used to calculate: $\varepsilon, u, u_b, p,$ and ρ . In order to solve the equation system, additional equations must be added: energy, e , burning rate, u_z , instantaneous gunpowder grain mass, m_z , propellant grain surface, S_z , influence of surface forces, f , and unit energy spent on heating gunpowder grains, q . The additional equations can be found in [11].

The system of equations defined for the two-phase flow model is solved by the finite difference method [14]. The choice of the finite differences shames is made so it will fulfill the conditions of stability and convergence of the numerical calculations.

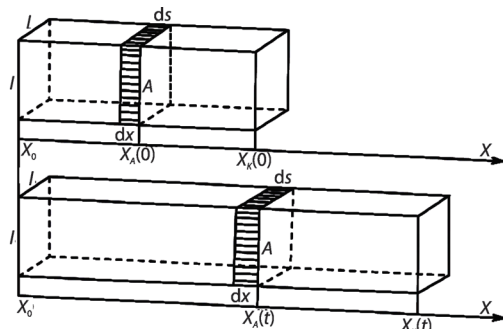

Figure 4. Lagrangian co-ordinate (t, s) [13]

All flow parameter values should be known at certain number of the independent variable x in order to calculate their values on the next time step. At each new time step, the movement of the projectile implies the appearance of new points at x for which some quantities in the system of equations are undefined. Their determination requires the use of some approximation procedures that may be incorrect. Substituting Eulerian co-ordinate (t, x) with Lagrangian co-ordinate (t, s) can overcome the use of approximations. The co-ordinate s represents the total mass (which is constant) of gun powder and gunpowder gases.

Parameter s is defined as a parallelepiped of width and height equal to the unit and an initial length of $X_k(0)$, fig 4. The number of points selected for this independent variable s remains the same for all the time steps [11].

In the elementary parallelepiped, bounded by the surface, A , and the length, dx , there is a mixture of gunpowder and gunpowder gases. Equations (19)-(23) are essential to substitute the Eulerian co-ordinate (t, x) with the Lagrangian co-ordinate (t, s).

$$ds = ds_g + ds_b \quad (19)$$

$$ds = (\rho S_g + \rho_b S_b) dx \quad (20)$$

$$s = \int_0^x [\rho \varepsilon + \rho_b (1-\varepsilon) s_b] dx \quad (21)$$

$$\frac{\partial}{\partial x} = [\rho \varepsilon + \rho_b (1-\varepsilon) s_b] \frac{\partial}{\partial s} \quad (22)$$

$$\frac{\partial}{\partial t} = \frac{\partial}{\partial t_1} - [\varepsilon \rho u + \rho_b u_b (1-\varepsilon) s_b] \frac{\partial}{\partial s} \quad (23)$$

The values of the pressure obtained at a specified time are not the same for different positions behind the projectile. The gas density values are also obtained for different positions along the barrel. Their determination allows the calculation of the gas temperatures using the equation of state. Figures 5(a) and 6(a) show a 3-D representation of the produced pressure for the two types of propellant. Figures 5(b) and 6(b) show the 3-D representation of the calculated temperatures. Figures 5(c) and 6(c) represent the pressure and the gas temperature in the measurement position as a function of time.

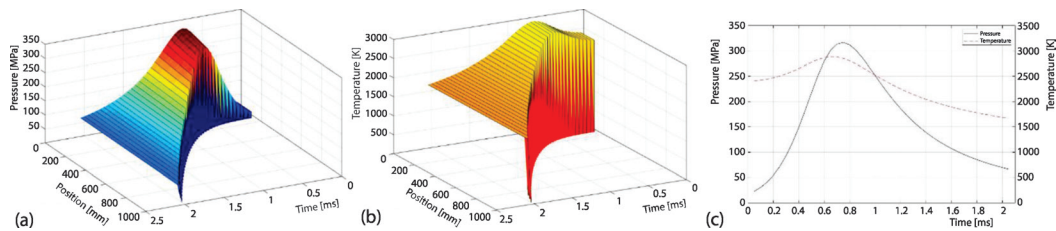

Figure 5. Pressure (a) and temperature (b) as a function of time and position for the C-type propellant, and (c) pressure and temperature in the measurement position as a function of time

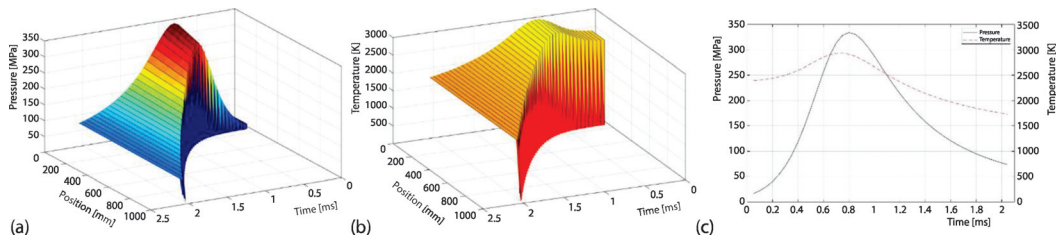

Figure 6. Pressure (a) and temperature (b) as a function of time and position for the S-type propellant, and (c) Pressure and temperature in the measurement position as a function of time

Experiments

Experimental tests of internal ballistics were performed using a standard 12.7 mm test barrel and they were carried out according to the permanent international commission (CIP) standard. The CIP lays down common rules and regulations for the proof of weapons and their ammunition in order to ensure the mutual recognition of Proof Marks by its member states. The tests were conducted in the test ballistic facility of Proof House Kragujevac.

Two types of propellants were used for the experiments: the seven-channel perforated cylindrical propellant and the spherical propellant. Full metal jacket bullets were used to perform the experimental tests. The mass of the projectile is 51.4 g, the mass of the propellant is 16 g and the length of the barrel is 1100 mm.

The test atmospheric conditions were standard (21 °C and 65% of humidity). The temperature of the propellant and the air inside the barrel were the same as the environmental temperature.

The sensors used to perform the experiments are the piezoelectric pressure sensors *Kistler 6215* (with a sensitivity of -1.4225 pC/bar and a measurement uncertainty of $\pm 1\%$). The pressure of the firing process was measured 25 mm from the bottom of the barrel. The second sensor is fixed at the muzzle, and it is used to stop the data acquisition when the combustion pressure reaches it. The muzzle velocity is measured using a ballistic chronograph placed 2.5 m from the muzzle. The used amplifier was a *Kistler 5015* and the acquisition module was an *Acquitek C*. Figure 7 provide a description of the measuring set-up.

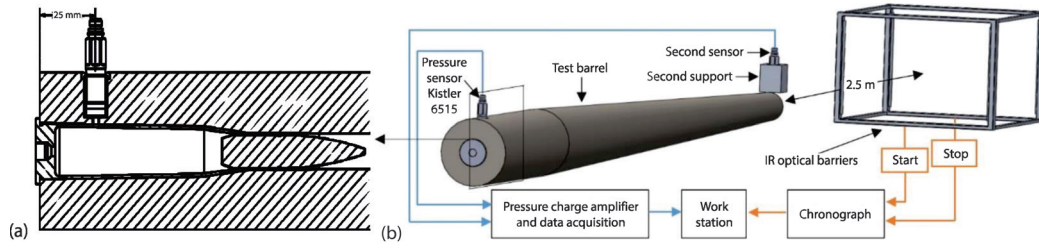

Figure 7. Position of the sensor in the barrel (a) and measuring set-up (b)

Results and discussion

The pressure calculated by the two-phase flow model is a time-space dependent pressure. The analytical and experimental results are compared with the values of pressure at the measurement position (at 25 mm from the bottom of the barrel). Figure 8 shows pressure time history during internal phase of experimental results compared with the obtained numerical and analytical pressures. The numerical and analytical calculations end when the projectile exits the gun. The graph shows that pressure evolution upon the firing process has the same tendency and that the agreement between the analytical, numerical and experimental values is satisfactory.

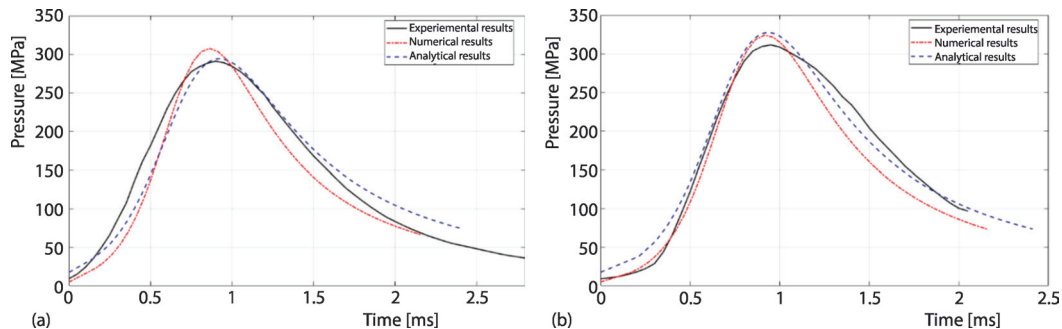

Figure 8. Analytical, numerical and experimental pressures; (a) C-type propellant and (b) S-type propellant

The reference time used to compare the results is when the projectile starts moving. For the numerical and analytical calculations, the reference time is when the value of the bullet position changes. For the experimental results, it is when the pressure reaches the values of the forcing pressure, p_0 . Table 1 summarizes the maximum pressures, the pressures at the muzzle and the related times, for both propellants and for all results.

The analytical model provides the average value of the pressures behind the projectile. The maximum pressure for the cylindrical propellant is 294.11 MPa, and for the spherical propellant, it is 327.26 MPa.

The pressures calculated with the numerical model have different values behind the projectile for both propellants as they are shown in figs. 5(a) and 6(a). The maximum pressure obtained with the numerical calculations at the sensor position is 307.36 MPa for the cylindrical propellant and 323.89 MPa for the spherical propellant.

The analytical model offers 1.06 % approximation for the maximal measured pressure for the C-type propellant and 5.09% for the S-type, while the numerical model gives 5.62% for the C-type and 4.02% for the S-type.

Table 1. Internal ballistics characteristics

		Analytical calculations	Numerical calculations	Experimental results
Maximum pressure, P_{\max} [MPa]	C-type	294.11	307.36	291.01
	S-type	327.26	323.89	311.38
Approximation error between calculated and measured P_{\max}	C-type	1.06%	5.62%	–
	S-type	5.09%	4.02%	–
Time to reach P_{\max} [ms]	C-type	0.77	0.65	0.83
	S-type	0.78	0.69	0.74
Muzzle pressure [MPa]	C-type	74.01	66.46	–
	S-type	73.59	73.41	–
Firing process duration [ms]	C-type	2.262	2.160	–
	S-type	2.247	2.157	–

The time needed for the projectile to exit the barrel is 2.262 ms for the cylindrical, and 2.247 ms for the spherical propellant according to the analytical model. However, it is 2.160 ms for the cylindrical and 2.157 ms for the spherical based on the numerical model.

The burning rate of the spherical propellant is quicker than the burning rate of the cylindrical propellant, as obtained by the analytical and the numerical models. The reached pressures are higher for the degressive burning gunpowder grains (S-type) than the progressive burning gunpowder grains (C-type).

The values of the projectile velocity at the muzzle calculated by the analytical and the numerical method are compared and validated with the values of the projectile velocity obtained experimentally. Table 2 presents the velocities obtained by the three approaches.

Table 2. Muzzle velocities

		Analytical calculations	Numerical calculations	Experimental results
Muzzle velocity [ms^{-1}]	C-type	799.25	768.85	768.74
	S-type	807.55	795.19	806.24
Percentage of the difference calculation vs. experiment	C-type	3.97%	0.01%	–
	S-type	0.16%	1.37%	–

The analytical model gives a 0.16% estimation of the measured muzzle speed for the spherical propellant and 3.97% for the cylindrical propellant. However, the numerical model offers an estimation of 1.37% for the S-type and 0.01% for the C-type. The acceptance of the calculated velocities is quite satisfactory.

Based on the satisfying agreements between the (analytically and numerically) calculated values of the pressure and velocity and the ones measured experimentally, the temperatures calculated by the two models are assumed to correspond to the real combusted gas temperature during the process.

The temperature calculated by the two-phase flow depends on time and position inside the barrel; therefore, the analytical results are compared with the values of the average temperature calculated numerically for each time step. Figure 9 shows the values of the calculated temperatures as a function of the projectile position during the firing process.

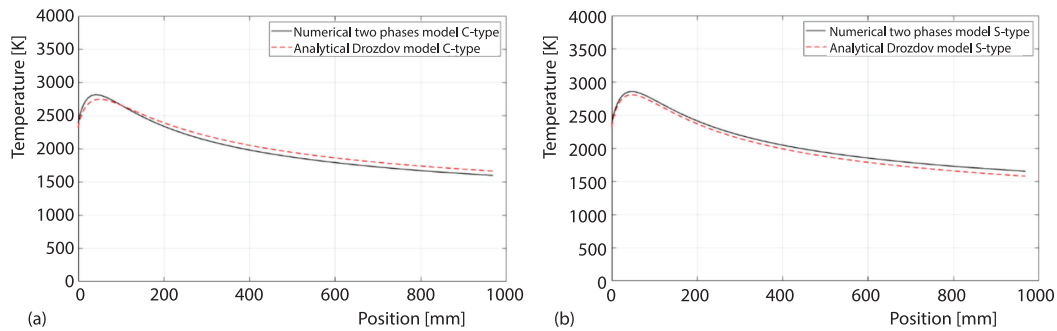

Figure 9. Gases temperatures as a function of the projectile position inside the barrel; (a) C-type propellant and (b) S-type propellant

The gas temperature released from the spherical propellant combustion is greater than the temperature of the gases released from the burning of the cylindrical propellant during the firing process, as shown in both fig. 2 and tab 3. Temperatures calculated numerically and analytically show less than 2.5% correspondence for the maximum values for the C-type propellant and less than 1.41% correspondence for the S-type propellant. The temperature profile as a function of the projectile position and the temperature profile as a function of the firing process time calculated using the two models have the same trend and almost the same values for both propellant types.

Table 3. Maximal temperatures obtained by numerical and analytical models

		C-type	S-type
Temperature [K]	Analytical calculations	2746.4	2807.5
	Numerical calculations	2816.7	2847.5
Difference [%]		2.49	1.40

The maximal temperature reached during the firing process for neither propellant exceed 2850 K. Exceeding this temperature value will lead to the creation of aggressive ions (H^- , OH^- , NO^- , N^- , O^-) [11], which are one of the main accelerating factors of the corrosion process (chemical corrosion) on the internal barrel walls. These conclusions are related to the previous stated research of Lawton, see [10] as the greatest influence of the temperature on the barrel erosion.

Conclusions

The research of internal ballistics parameters was performed using two different models (analytical and numerical) for two types of gunpowder. Experimental tests were performed for two propellants in order to validate the calculated internal ballistics parameters of both models. The comparison of the results obtained for the two models with the experimental test results showed excellent matches for the values of gunpowder gas pressures and the projectile muzzle velocities. The aim of the research was to evaluate the reliability of the two-phase flow model (numerical model) by comparing it with the conventional analytical model, widely used in weapon and ammunition design. Experimental results of the pressure values in the specific cross-section of the barrel (according to the CIP standard), showed a very good agreement for both models and both types of gunpowder. The matches of the maximum pressures were up to 1.06% for the C-type, and up to 5.09% for S-type, according to the analytical model. However,

they were up to 5.62% for the C-type, and up to 4.02% for S-type according to the numerical model. The experimental results of the muzzle velocity values (according to the CIP standard) also showed a very good compatibility for both models and for the both types of propellants. The matches of the muzzle velocities were up to 3.97% for the C-type, and up to 0.16% for the S-type, according to the analytical model. Nevertheless, the matches were up to 0.01% for the C-type, and up to 1.37% for the S-type, according to the numerical model.

The research presented two models for calculating the gases temperatures in the barrel. The matching between the results of the analytical and numerical model is satisfying. The profile change tendency and the compatibility of maximal temperatures (up to 2.49% for the cylindrical propellant and up to 1.4% for the spherical propellant) are quite good. Based on the presented temperature results, it can be concluded that the ammunition is optimally designed. The gas temperature does not exceed the critical temperature which leads to aggressive ions formation.

Furthermore, experimental determination of the gases temperatures in the barrel is very complex, expensive (thermocouples) and of questionable reliability. Therefore, calculating the gunpowder gas temperature using the analytical and the numerical model makes a great contribution to the process of designing weapons and ammunition.

The propellant grain geometry affects the interior ballistic output parameters. Spherical propellants release more pressure and temperature compared to the same amount of cylindrical propellants. Spherical propellants accelerate the projectile to higher velocities. However, they apply more thermo-mechanical stress on the barrel which will reduce the gun barrel life.

The analytical model gives an average value for the flow parameters (pressure and temperature) for the volume behind the projectile as a function of time. However, the values of flow parameters provided by the numerical model are time-space dependent values. Which makes it more convenient to use as a good solution in the weapon system design process.

Acknowledgment

The research was supported by the Proof House for Experimental Testing, Kragujevac, Republic of Serbia.

Nomenclature

e – internal energy of gases, [Jkg ⁻¹]	t – time, [s]
e_b – internal energy of gunpowder grains, [Jkg ⁻¹]	u – combustion gases velocity, [ms ⁻¹]
f_b – propellant force, [Jkg ⁻¹]	u_b – gunpowder grains velocity, [ms ⁻¹]
k – specific heat ratio (= c_p/c_v), [-]	u_z – gunpowder combustion velocity, [ms ⁻¹]
M_i – molar mass of propellant gases components, [kgkmol ⁻¹]	u_{z0} – burning coefficient [ms ⁻¹ Pa ⁻¹]
m_b – propellant mass, [kg]	V – volume behind the projectile, [m ³]
m – projectile mass, [kg]	v – projectile velocity, [ms ⁻¹]
m_z – instantaneous gunpowder grain mass, [kg]	W_0 – combustion chamber volume, [m ³]
p_0 – forcing pressure, [Pa]	w_b – volume occupied by gunpowder grains, [m ³]
p – pressure in the barrel, [Pa]	w_g – volume occupied by gases, [m ³]
q – unit energy spent on heating gunpowder grains, [-]	X – location of the projectile in the barrel, [m]
\mathfrak{R} – universal gas constant, 8.314 [Jkmol ⁻¹ K ⁻¹]	X_u – length of the barrel, [m]
R – gas constant, [Jkg ⁻¹ K ⁻¹]	x_i – molar fraction, [-]
r_0 – initial thickness of gunpowder, [m]	y – relative burned thickness of the gunpowder grain, [-]
S_c – inner cross-sectional of the barrel, [m ²]	
S_z – surface of gunpowder, [m ²]	
T – temperature, [K]	

Greek letters

α – co-volume of the combustion gases, [m ³ kg ⁻¹]
ε – porosity, [-]

λ – shape (form) coefficient, [–]
 μ – shape (form) coefficient, [–]
 ρ – gas density, [kgm^{-3}]

ρ_b – propellant density, [kgm^{-3}]
 φ – minor work coefficient
 ψ – mass fraction of burned propellant, [–]

References

- [1] Akcay, M., Internal and Transitional Ballistic Solution for Spherical and Perforated Propellants and Verification with Experimental Results, *Thermal Science and Technology*, 37 (2017), 1, pp. 35-44
- [2] Jaramaz, S., et al., Two-Phase Flows in Gun Barrel: Theoretical and Experimental Studies, *International Journal of Multi-Phase Flow*, 37 (2011), 5, pp. 475-487
- [3] Bougamra, A., Lu, H., Multi-Phase CFD Simulation of Solid Propellant Combustion in a Small Gun Chamber, *International Journal of Chemical Engineering*, 2014 (2014), ID971808
- [4] Senturk, A., et al., Thermo-Mechanically Coupled Thermal and Stress Analysis of Interior Ballistics Problem, *International Journal of Thermal Sciences*, 104 (2016), June, pp. 39-53
- [5] Rezgui, N., et al., Experimental and Numerical Analysis of Thermo-Chemical Erosion in Gun Steel, *Thermal Science*, 23 (2019), 2, pp. 4135-4145
- [6] Jevtić, D. T., et al., Modelling of Gas Parameters in the Cylinder of the Automatic Gun During Firing, *Thermal Science*, 24 (2020), 6B, pp. 152-152
- [7] Corner, J., Theory of the Interior Ballistics of Guns, *The Journal of Criminal Law, Criminology, and Police Science*, 42 (1950), 6, 846
- [8] Unosson, M., et al., The 2-D Finite Element Model for Simulation of the Interior Ballistics of Guns, Report No. FOI-R-1690-SE, FOI – Swedish Defense Research Agency Weapons and Protection, Sweden, 2005
- [9] Mishra, A., et al., A Novel Scheme for Computing Gun Barrel Temperature History and Its Experimental Validation, *Journal of pressure vessel technology*, 132 (2010), 6, pp. 881-888
- [10] Lawton, B., Thermo-Chemical Erosion in Gun Barrels, *Wear*, 251 (2001), 2, pp. 827-838
- [11] Cvetković, M., *Internal Ballistics* (in Serbian), SŠOVID-VTA., Belgrade, Serbia, 1998
- [12] Zhuo, C. F., et al., Research on the Muzzle Blast Flow with Gas-Particle Mixtures Based on Eulerian-Eulerian Approach, *Journal of Mechanics*, 32 (2016), 2, 185
- [13] Tančić, Lj., *Exercises in Internal Ballistics in Serbian language*, VTA, Belgrade, Serbia, 1999
- [14] Iserles, A., *Numerical Solution of Partial Differential Equations: Finite Difference Methods*, 3rd ed., (Ed. Smith, G. D.), 1985, p. 337. ISBN 0-19-859641-3/859650-2 (Oxford University Press), *The Mathematical Gazette*, 70 (1986), 454, pp. 330-332