



A Design Methodology for an Innovative Racing Mini Motorcycle Frame

Luca Di Angelo¹ , Paolo Di Stefano² , Cristina Renzi³  and Francesco Leali⁴ 

¹University of L'Aquila, L'Aquila, Italy, luca.diangelo@univaq.it

²University of L'Aquila, L'Aquila, Italy, paolo.distefano@univaq.it

³University of Modena and Reggio Emilia, Modena, Italy, cristina.renzi@unimore.it,

⁴University of Modena and Reggio Emilia, Modena, Italy, francesco.leali@unimore.it

Corresponding author: Cristina Renzi, cristina.renzi@unimore.it

Abstract. Sports equipment design is a young and evolving engineering discipline focused on the best simultaneous optimization of user and product as a system. In motorsports, in particular, the final performance during a race depends on many parameters related to the vehicle, circuit, weather, and tyres and the personal feelings of every single driver. Top teams in high-tech categories can invest huge amounts of money in developing simulators, but such economic commitment is not sustainable for all those teams that operate in minor but very popular categories, such as karts or mini-motorcycles. In these fields, the most common design approach is trial and error on physical prototypes. Such an approach leads to high costs, long optimization times, poor innovation, and inefficient management of the design knowledge. The present paper proposes a driver centred methodology for the design of an innovative mini racing motorcycle frame. It consists of two main phases: the drivers' feelings translation into engineering requirements and constraints, and the exploration of the design solution space. Expected effects of the application of the proposed methodology are an overall increase in the degree of innovation, time compression, and cost reduction during the development process, with a significant impact on the competitiveness of small racing teams in minor categories.

Keywords: design methodology, racing motorcycle frame design, topological optimization.

DOI: <https://doi.org/10.14733/cadaps.2020.1116-1129>

1 INTRODUCTION

This template file contains all relevant information to process papers into the right format for the journal CAD and Applications. Please do not change the preset styles. Either type your paper directly

into this file, substituting appropriate paragraphs and headings, or bring in your text in a plain format and then change it to the appropriate style by simply selecting the intended style from the menu in the MS-Word toolbar.

The following sections summarize the parameters used in the various pre-set styles. You should never really have to deal with these parameters directly, but only select one of the pre-formatted styles. But for completeness of documentation this information is given here, so that future managers of this template may more easily make selective changes to some of the styles.

Sports equipment design is a young and evolving engineering discipline. Compared to typical product design, the key difference is that the user and the product need to be considered as an integrated system. As a consequence, sports equipment designers engage deeply with the athletes throughout the entire design process ([16]). In this interaction, one of the most challenging design tasks is to understand the personal requirements of users for the optimization of the equipment.

The biggest difficulty for designers in these activities lies in the fact that feelings and perceptions are often expressed by users verbally without applying any systematic methodology. Moreover, periodic design reviews are needed due to changes in regulations or in the homologation validity. These points are well known for tennis racquets, golf clubs, running shoes, football boots, and skis ([16],[17]) but can also be considered valid for motorsports. Indeed, the final performance during a competition depends on the driver/vehicle system. Here, many parameters related to the dynamic behaviour of the vehicle, the peculiar characteristics of every circuit in any weather condition and the temporal evolution of tyres, generate thousands of possible setups, which can't be optimized during the race weekend for every single driver.

Teams in high-tech motorsport categories (e.g. Formula 1, MotoGP) invest in the development of static or dynamic simulators ([14]), which are exploited to test the compliance of setups with the driving skills and habits of drivers. However, such economic commitment is not sustainable for all those teams that operate in minor categories, such as karts or mini-motorcycles, which are very important for the stakeholders involved and the overall market impact, even if are comparable only to micro, small, and medium enterprises. In these fields, the development or redesign of new components is typically based on the trial and error design approach and the production of physical prototypes for every significant step of the design process, according to the desiderata of drivers. Such an inefficient approach leads to high costs, long optimization times, and a very low degree of innovation for every component, due to a rough exploration of the design space. Moreover, the engineering knowledge captured by teams is very poor, highly dependent on the experience of individual technicians, and difficult to reuse in further seasons. These limitations can be significantly reduced by introducing a systematic methodology for the design of the first prototype, accessible to the small teams involved in the aforementioned motorsport categories

For these purposes, the present paper proposes a methodology based on two main phases: first the translation of drivers' feelings into engineering requirements and constraints. Second, the subsequent exploration of the design solution space, by means of engineering knowledge management tools such as state-of-the-art computer-based software. The methodology is applied to the design of a racing mini motorcycle frame. It represents one of the most important components subjected to continuous development during a racing season, due to its decisive influence on the stability and handling of the motorcycle, producing a significant effect on the driver's perceptions and, consequently, on the lap time. Expected effects from the application of the proposed methodology are an overall increase in the degree of innovation, time compression, and cost reduction during the development process, with a significant impact on the competitiveness of small racing teams in minor categories.

The paper is structured as follows. In the next section, the existing approach for designing a mini motorcycle frame is presented. Then the proposed methodology is described. In Section 3, the results of the development of the mini motorcycle frame are presented and discussed.

2 EXISTING APPROACH TO THE DESIGN OF RACING MINI MOTORCYCLE FRAMES

In the “as is” scenario, the design of the first prototype of a mini motorcycle frame and its modification can be described as shown in Figure 1. The approach is also adopted for the design of many other components and follows some well-known guidelines (e.g.[5],[8],[9]); it also exploits Computer Aided Engineering (CAE) techniques.

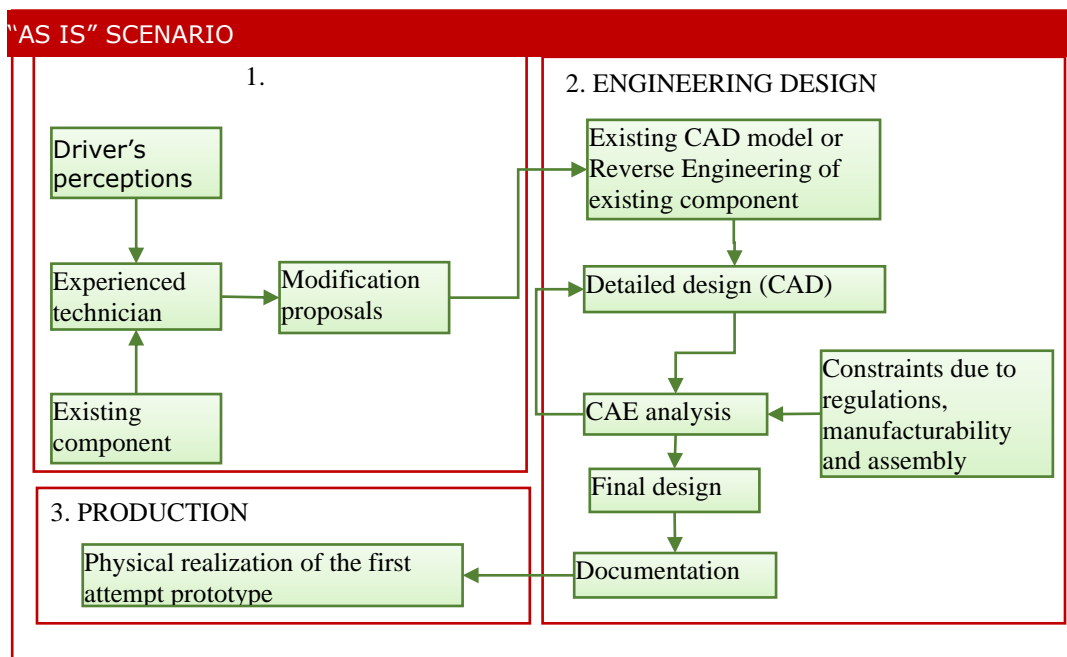

Figure 1: Workflow of the existing scenario.

The first phase consists of the *interpretation of the driver's perceptions* when using an existing frame. In this phase, (experienced) technicians propose design modifications according to the personal perceptions gained from (expert) drivers testing the last season's frame directly on a test track.

The second phase is the *engineering design*, in which an existing CAD model or a digital model obtained by reverse engineering is modified to be compliant with regulations, manufacturing, and assembly, paying attention to the overall cost. During the conceptual design phase, optimization algorithms often help designers in the evaluation of novel geometries (e.g. [7]). In the embodiment design phase, the rules of Design for Manufacturing and Assembly (DFMA) ([2]) are adopted. Hence, decisional techniques are often used for the selection of the most suitable design alternatives (e.g. [11]). Within the last few years, CAE simulations have been intensively and rapidly developing, from the FEM analysis of individual components to complex analysis consisting of integrated multi-body simulation, structural analysis, fluid dynamic analysis, virtual prototyping, and topology optimization ([1]). Furthermore, lately, optimization algorithms have been adopted to enhance the design of components in motorsport engineering, due to their capability to explore the design search domain within predefined boundary constraints ([15]). As an example, a pattern search algorithm has been used to optimize the stability and handling of a Moto2 motorcycle, in order to increase the stiffness of the frame, in terms of mass reduction and performance enhancement ([13]). Sapanaro et al.

([12]) proposed a response surface optimization method to develop an optimal motorcycle swing arm.

Finally, a first-attempt physical prototype is produced. Such a prototype is often tested on the same track and modified again according to the new data collected by telemetry and according to the drivers' feelings. The loop ends when the obtained solution, developed around a well-known initial proposal, is considered satisfactory. The consequences of such an approach are that the new frame is rarely innovative, the development process is very slow, and the overall cost is high for a small team. Furthermore, there is no certainty that the final solution is the optimal one, since it depends on a partial investigation of the design solution space and on the skill of drivers and engineers in correlating some personal feelings to objective design requirements. Moreover, when a technician or driver leaves the team, all the knowledge about the optimization process is suddenly lost.

3 A DRIVER-CENTERED APPROACH TO THE DESIGN OF RACING MINI MOTORCYCLE FRAMES

The proposed design methodology for the design of a new racing mini motorcycle frame is aimed at guiding the designer to correlate drivers' perceptions with engineering constraints and requirements for the investigation of a larger domain of solutions (Figure 2).

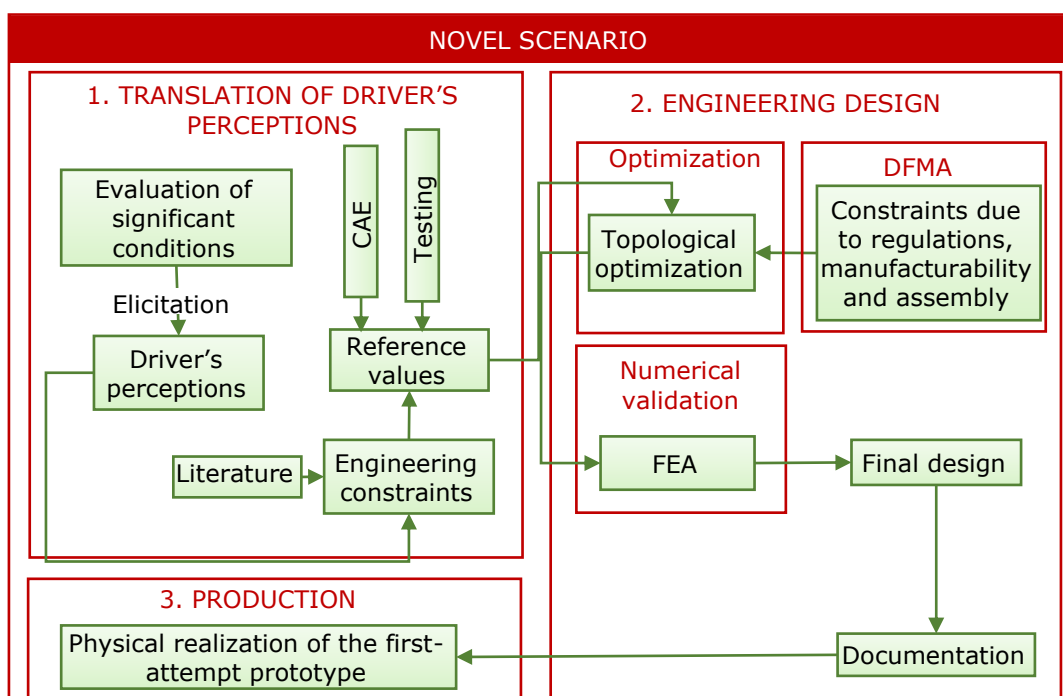

Figure 2: Workflow of the existing scenario.

During the *translation of the drivers' perceptions* to engineering constraints and requirements, two main steps concerning the collection of the drivers' perceptions and their translation into engineering constraints are defined. In the first, the significant conditions needed to carry out a survey are defined and the data are collected by means of elicitation. Knowing the drivers' perceptions, the

engineering constraints and their reference values are evaluated from the literature and by specific CAE simulations and/or experiments.

In the *engineering design* of new racing mini motorcycle frame, the engineering constraints are used as input to the topological optimization and for a static FEA validation. Starting from the shape validated by the numerical analysis, the final design is obtained by introducing manufacturing and assembly constraints.

In the following two sub-sections, the phases of the methodology which allowed the design of the new geometry are presented.

3.1 Translation of Drivers' Perceptions

The translation of users' feeling about the driveability is complex, since their perceptions vary at every instant during the race. Moreover, the driver uses his or her memory to record sensations and perceptions, transmitting them only at the end of the race or practice session (Peng 2017). Furthermore, different drivers have different driving sensitivities and different capabilities as testers.

In order to identify the stability and handling characteristics required of a mini motorcycle frame, 20 riders with different experiences, skills, and sensitivities were interviewed. For all of them, the fundamental parameters affecting the performance of a mini motorcycle are:

- corner entry stability;
- turning stability.

Such indicators, together with the limits imposed by specific regulations, were used as criteria to benchmark the most widely racing frames available on the market:

- the *trellis frame*, made of steel welded tubes;
- the *Deltabox*, made of two steel flat arms connected together on the steering pin.

In particular, drivers' judgments have been provided on a numerical scale (1 to 10) for judging the corner entry stability and the turning stability for both the frames. Drivers have been categorized into three groups according to the level of driving experience: basic level (up to three years of experience), medium level (up to five years of experience), and high-level (more than five years of experience). Judgments have been weighted according to the level drivers belong. In particular, the less experienced is the driver, the minor is the weight used for weighing the judgment. The resulting judgment for each criterion is the average of the weighted ones. The results of the drivers' judgments on the two frames are reported in Table 1.

According to the drivers' experience resulting performance of the two different frame typologies mentioned above present are the following:

- the *trellis* frame (*Frame 1*) presents high turning stability and low corner entry stability.
- the *Deltabox* frame (*Frame 2*) presents low turning stability and high corner entry stability.

All the drivers agreed that neither solution is optimal, even if the most commonly used is Frame 1 because stability is more important for their driving perceptions during the curves than in the curve entrance.

As reported in the literature, the stability and handling characteristics of a motorcycle perceived by the rider during turning are strictly correlated to the torsional and flexural stiffness ([3], [4], [6]): in the case of low-stiffness, the perception is of a slow and heavy motorcycle; conversely, a more rigid structure will lead to the perception of better receptiveness and handling.

The torsional stiffness (K_t) can be evaluated by using the following expression:

$$K_t = \frac{M_{tt}}{\alpha} \quad (3.1)$$

where M_{tt} is the applied torsional moment. Under the assumptions of:

- linear elasticity,

- small displacements, and
- small deformations,

the angle α can be evaluated according to the schematization reported in Figure 3, with l_a and l_b being the maximal displacements.

	drivers	trellis frame		Deltabox frame	
		corner entry stability	turning stability	corner entry stability	turning stability
Basic level drivers	1	4	7	9	2
	2	3	7	9	3
	3	4	7	9	2
	4	3	8	8	3
	5	3	9	9	2
	6	2	9	8	3
"basic level" weight	0,7	3,2	7,8	8,7	2,5
weighted average for basic level drivers		2,2	5,5	6,1	1,8
Medium level drivers	7	3	7	9	2
	8	3	8	8	4
	9	2	7	8	3
	10	3	8	8	4
	11	3	8	8	4
	12	2	7	8	3
"medium level" weight	1	2,7	7,5	8,2	3,3
weighted average for medium level drivers		2,7	7,5	8,2	3,3
High level drivers	13	3	8	8	2
	14	3	8	8	2
	15	2	9	8	3
	16	3	9	8	3
	17	3	9	8	2
	18	3	8	9	2
	19	3	8	8	2
20	4	8	8	3	
"high level" weight	1,3	3	8,4	8,1	2,4
weighted average for high level drivers		3,9	10,9	10,6	3,1
result		2,9 (low)	8,0 (high)	8,3 (high)	2,7 (low)

Table 1: Numerical judgments related to the trellis and deltabox frames.

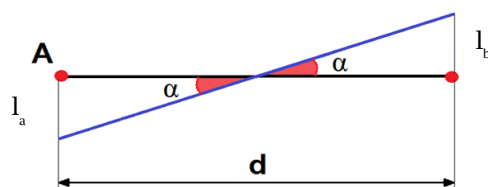

Figure 3: Scheme for evaluation of the torsional stiffness.

The expression of flexural stiffness (K_f), under the assumptions that the fixed constraint is positioned in the rear wheel axis and the load is on the front suspension, is as follows:

$$K_f = \frac{M_f/l}{d_{max}} \quad (3.2)$$

where:

- M_f is the applied flexural moment;
- L is the frame length;
- D_{max} is the maximum displacement.

The measurement of the stiffness in existing frames is difficult, especially because separation of the flexural moment from the torque during loading is not completely possible (e.g. [1128]). Hence, in this specific case study, FEA results have been used for the evaluation of the reference values for the torsional and flexural stiffness. In the proposed methodology, this evaluation is performed in two sub-steps, namely *reverse engineering* (RE) and FEA (Figure 4).

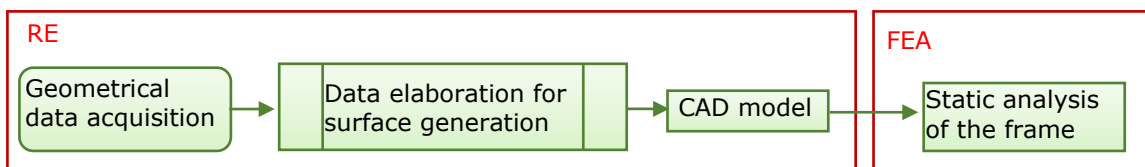

Figure 4: Calculation steps for reference values of the torsional and flexural stiffness.

The geometrical data acquisition (Figure 5, A) delivers a cloud of points as its output, to be connected in a polygonal mesh and rebuilt by means of NURBS (Non-Uniform Rational B-Splines) surfaces (Figure 5, B). Imported NURBS surfaces in a CAD environment (Figure 5, C) help in generating peculiar curvatures and shapes for CAD model generation (Figure 5, D). The CAD models have been discretized by means of finite elements.

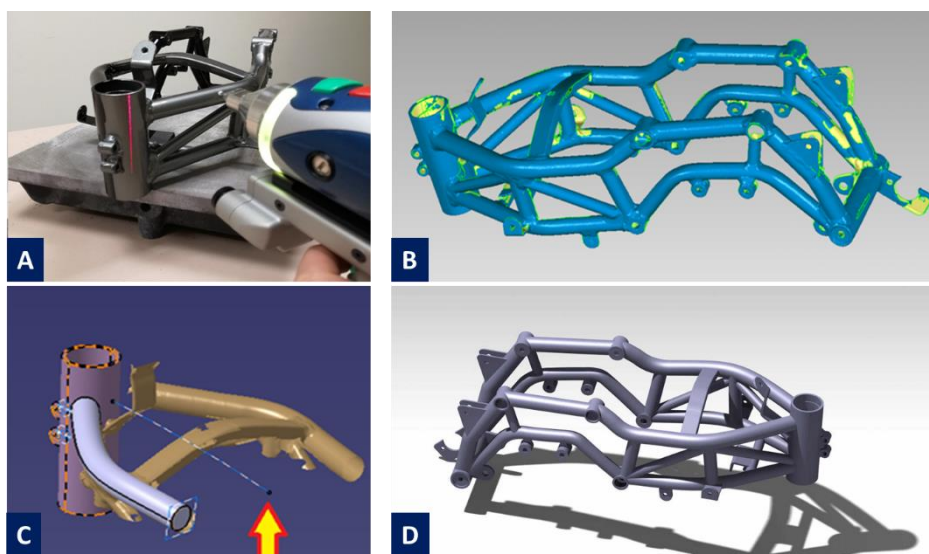

Figure 5: Reverse engineering on the frame (A: geometry acquisition, B: NURBS generation, C: spline definition for the path; D: generated CAD model).

Figure 6 and Figure 7 show the schematizations and formulas used to calculate, respectively, the flexural (Figure 6) and torsional (Figure 7) moments. In particular, design parameters as n , h , l

depend on the angle β , which is the inclination of the frame once mounted on the mini-motorbike. These parameters depend also on the tyre contact point with the asphalt and the radius of the front wheel (a).

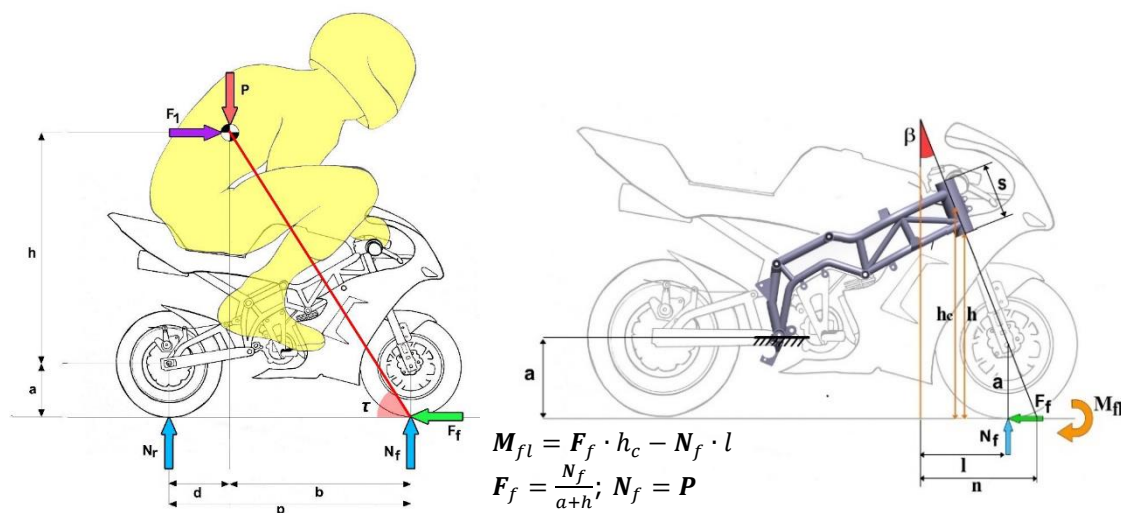

Figure 6: Load configurations and equations used to calculate M_{fi} .

The flexural moment is evaluated under the assumptions of the maximal braking limit on the front wheel; substituting the values referred to in the test case in the expressions of Figure 6, the following flexural moment is obtained:

$$\mathbf{M}_{fi} = -116.25 \text{ Nm} \quad (3.3)$$

The torsional moment is valued by considering the following simplifying hypotheses:

- a constant-radius curve;
- constant motorcycle speed $v \rightarrow$;
- negligible gyroscope effect;
- null corner drift of the rear and front wheels (λ_r, λ_f);
- point-to-point contact between wheels and asphalt;
- tyres in pure rolling condition;
- nil wheel-tightening torque;
- a radius of curvature R_c much greater than the pitch of the mini motorcycle p ;
- load transfer due to a negligible contribution of aerodynamic force compared to the vertical loads on the wheels;
- zero yaw moment.

In the expressions shown in Figure 7, substituting the values for the test case considered here, the torsional moment is as follows:

$$\mathbf{M}_{tt} = 83 \text{ Nm} \quad (3.4)$$

Fixed restraints are applied to the frames in the Altair® OptiStruct environment, as reported in Figure 8 A and B. Flexural and torsional moments are applied to the steering head centre point of both frames (Figure 8 C). Material properties of the 25 CrMo4 steel (the typical material used for the mini-moto bike frame) are set for the model.

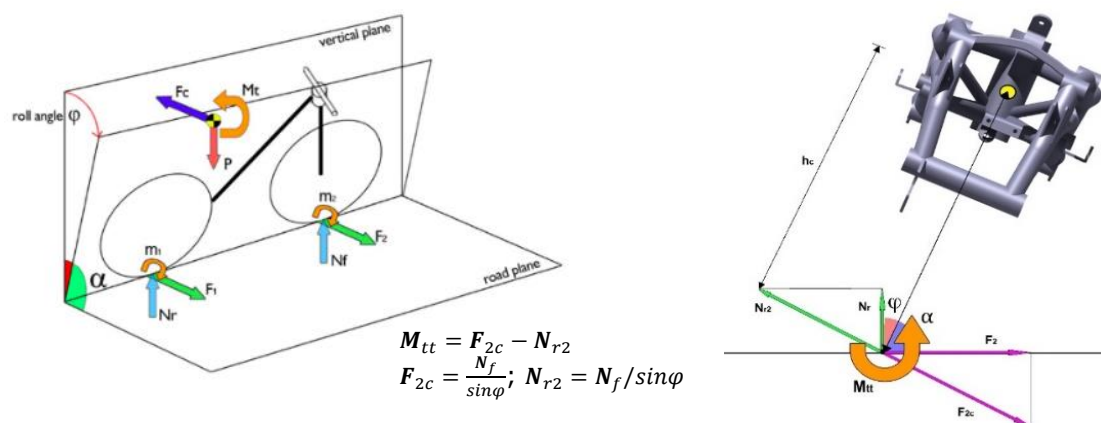

Figure 7: Load configurations and equations used to calculate M_t .

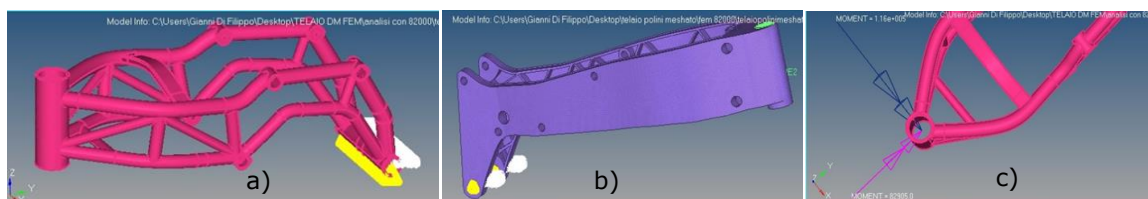

Figure 8: Boundary conditions on the frames.

Figure 9 depicts the results in terms of displacement for the two frames and for the two moments. Substituting the corresponding moments' values (M_{tt} and M_f) and the maximum displacements obtained by FEA analysis into expressions (1) and (2), the values of torsional and flexural stiffness reported in Table I are obtained. The results show a higher flexural stiffness for the *Deltabox* and a higher torsional stiffness for the *trellis* frame. Consistently with considerations reported in the literature, the flexural stiffness is higher for the *Deltabox* frame, which means that it is more stable during braking, to the detriment of manoeuvrability when entering the curve. Moreover, the greater torsional stiffness of the *trellis* frame justifies greater stability in the curve distance compared to the *Deltabox*.

3.2 The Engineering Design of the New Mini Motorcycle Frame

In order to conceive a novel frame, a topological optimization is adopted with the aim of exploring a larger domain of solutions for mass minimization and stiffness maximization. A block-shaped geometry is built in the CAD with the overall volume of the frame (Figure 10). The holes for the steering tube and the rear swing arm are added to the CAD model, together with the related bushes. Hence, the model is imported into Altair's Inspire software. The material assigned is 25CrMo4 steel (the typical material used for the mini-moto bike frame). The constraints used for the topological optimization are the values of K_t of the *trellis* and K_f of the *Deltabox* (Table 1).

The model for the topological optimization is restrained by requiring a maximum stiffness of 20% of the design space and a maximal profile thickness of 20 mm. Two models resulted from the topological optimization: one optimized for maximal stiffness, (Figure 11a), the other for minimal weight (Figure 11 b).

Starting from a trade-off model of the frames optimized in terms of minimal weight and maximal stiffness, a CAD model of a novel frame is built. In particular, the trade-off model has been designed as follows. The rear of the frame has been maintained as similar as possible to the frame depicted in Figure 12 a), in order to increase stiffness. Concurrently, the front part of the frame has been designed as similar as possible to the one depicted in Figure 12 b), for weight reduction and reinforced to increase stiffness and allowing manufacturing. The design of the trade-off frame followed the rules of design for manufacturing (Figure 12). Simplified shapes (same diameter for holes wherever possible) have been used for ease of part fabrication. Moreover, rules of near net shape processes have been followed as well as simplifications on part geometries.

Flexural moment

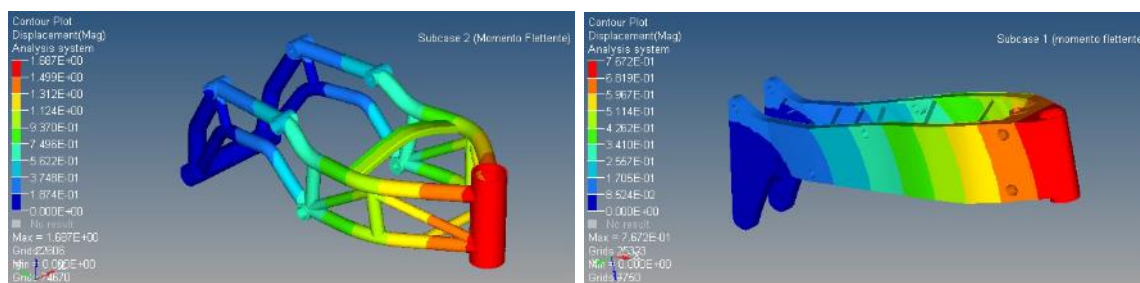

Torsional moment

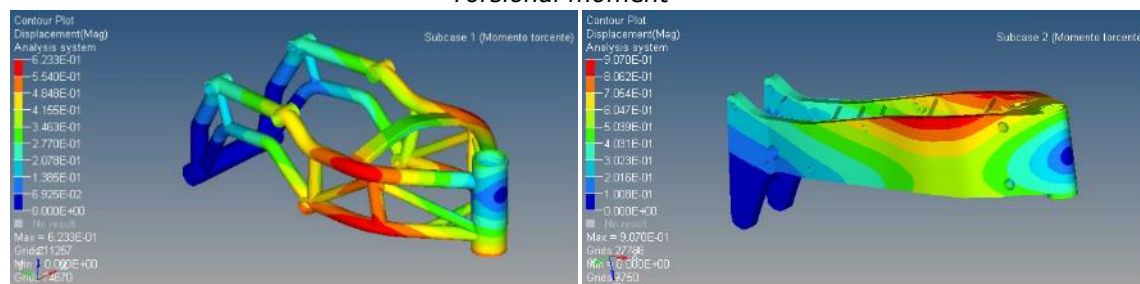

Figure 9: Displacement on the two frames after application of the flexural and torsional moments.

	K_t (Nm/deg)	K_f (N/mm)
Trellis frame	208.9	156.6
Deltabox frame	103.7	344.4

Table 2: Resulting values of torsional and bending stiffness for the frames.

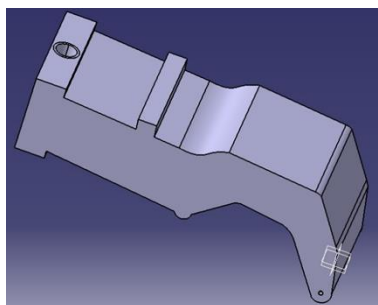

Figure 10: CAD model taken as input for the topological optimization.

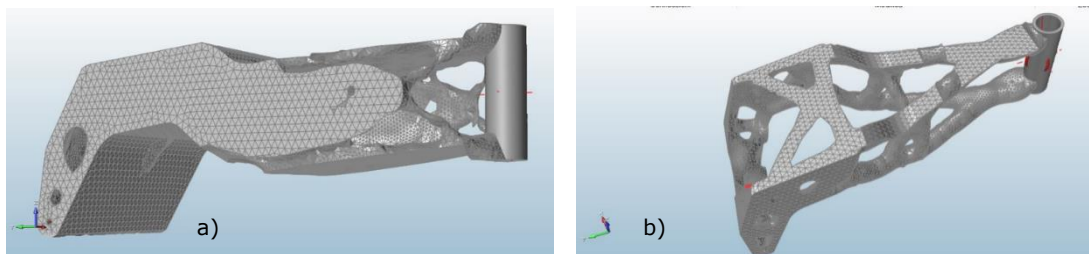

Figure 11: Models optimized for maximal stiffness (a) and minimal weight (b).

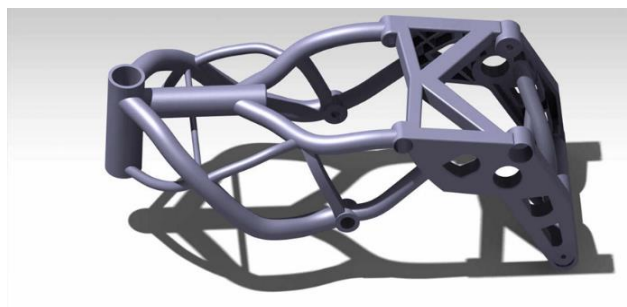

Figure 12: Concept design of the novel optimized frame.

FEA of the new frame is required in order to verify that the shape modifications introduced in the DFMA do not strongly affect the values of \bar{K}_t and \bar{K}_f (Figure 13). By using the same equations and boundary conditions as in Section 3, new values of the stiffness are obtained. The obtained values of percentage errors (Table 3) are so small that it is possible to assume for the frame the values of \bar{K}_t and \bar{K}_f .

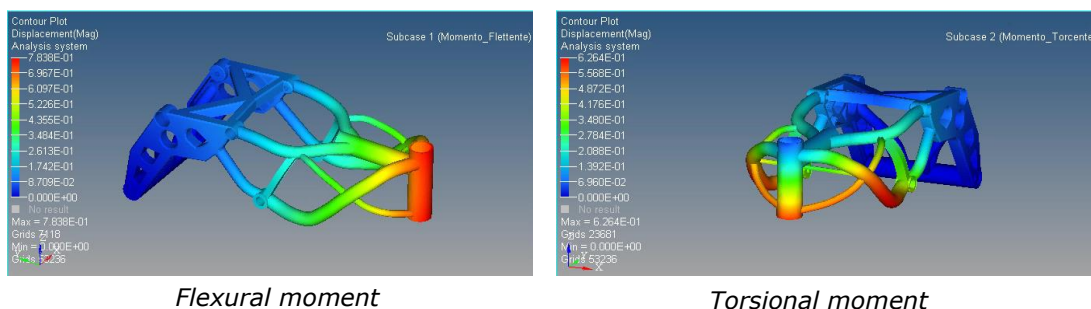

Figure 13: Displacement on the new frame after application of the flexural and torsional moments.

	Reference value	Optimised frame value	Err [%]
K_t	208.9	207,90	0.48%
K_f	344.4	337,08	2.10%

Table 3: Value and percentage errors for the torsional and flexural stiffness of the references and the novel frame.

4 DISCUSSION AND CONCLUSION

In this paper, a systematic design methodology for the development of a new first prototype of a racing mini motorcycle frame is proposed. In the proposed paper, two peculiarities can be highlighted: first, the drivers' perceptions of driving have been taken into account as criteria for the evaluation of design parameters describing the frames; second, the optimization has been applied before the detailed design phase, in order to find the definitive shape for the frame.

Figure 14 summarizes the methodology implementation. Starting from the geometry of the existing frames and the corresponding principal perceptions of the drivers, the proposed methodology leads to the result of a frame with an innovative shape. The resulting frame, obtained by the knowledge codification of the behaviour of the two existing ones, is a hybrid solution, which presents both references values of stiffness (the flexural stiffness of the *Deltabox* frame and the torsional stiffness of the *trellis* frame), with a reduction in the frame mass of about 10%. Due to the mass reduction and the stiffness enhancement, the hybrid frame is expected to offer an interesting performance. Such results will be validated in next experimental campaigns realized in collaboration with an experienced racing mini motorcycle team. The same team measured a 20% reduction in the time spent on frame development, as a result of the efforts in testing small modifications of parts and translating the experience of nonprofessional drivers into technical requirements. Moreover, a significant decrease of the cost was obtained with respect to the trial and error approach considering, on one hand, the investment needed to arrange a computer-based laboratory and, on the other, the reduction of the total number of prototypes needed to achieve competitive results on the track. The computer-based approach, finally, allows the team to store the knowledge drawn from the development process and reuse it for further analysis focused on the same component or to apply the same approach to other parts of the motorcycle.

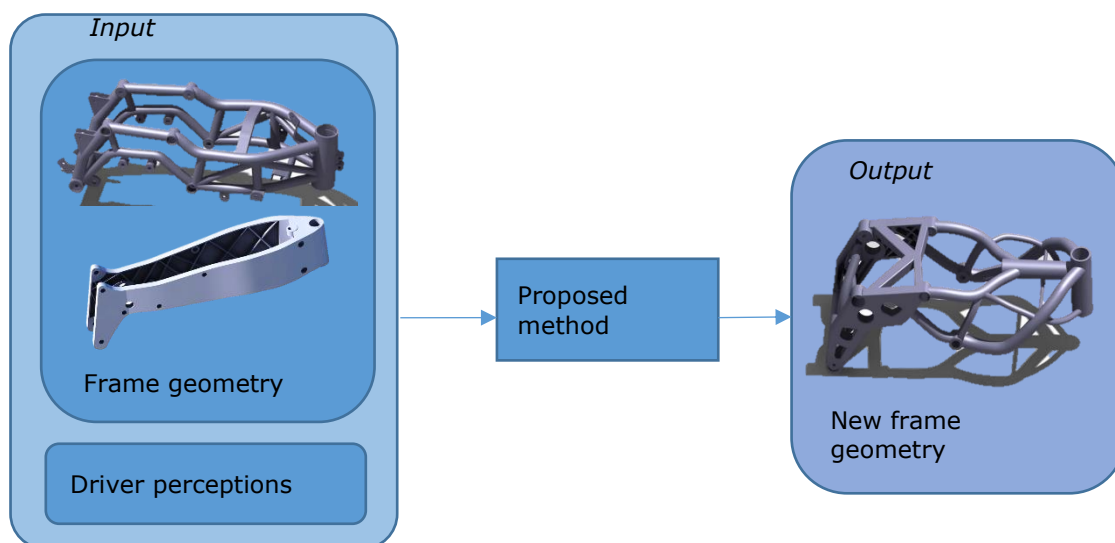

Figure 14: Comparison of the original frame geometries with the novel one.

The methodology proposed for the design of the first prototype can also be used for the optimization loop: by means of the engineering design and production phases, new shapes with different references values of the stiffness can be produced. The designer, on the basis of the indications received by the drivers in tests on the track, could modify the reference values of engineering

constraints and perform the stages of development and production again. This would involve a significant reduction in the total number of iterations with respect to a trial and error approach.

Future work will address the extension of the method to other areas of sports competitions, for which the user and the product can be considered as a single system and the final performance depends on the accuracy in transforming the users' perceptions into engineering constraints and requirements.

Luca Di Angelo, <http://orcid.org/0000-0002-5341-0500>
Paolo Di Stefano, <http://orcid.org/0000-0001-5003-2084>
Cristina Renzi, <http://orcid.org/0000-0002-1629-0036>
Francesco Leali, <http://orcid.org/0000-0001-6621-5379>

5 REFERENCES

- [1] Ballo, F.; Gobbi, M.; Massera, M.; Mastinu, G.: A race motorcycle frame: Advanced design. In: proceedings of ASME 2014 International Design Engineering Technical Conferences and Computers and Information in Engineering Conference (pp. V003T01A031–V003T01A031). American Society of Mechanical Engineers. <https://doi.org/10.1115/DETC2014-34339>
- [2] Boothroyd, G.; Dewhurst, P.; Knight, W.: Product design for manufacture and assembly, Marcel Dekker, New York, NY, 2002.
- [3] Cossalter, V.; Lot, R.; Massaro, M.: The influence of frame compliance and rider mobility on the scooter stability, *Vehicle System Dynamics*, 45(4), 2007, 313–326. <https://doi.org/10.1080/00423110600976100>
- [4] Doria, A.; Taraborrelli, L.: Identification of the critical stiffnesses of motorcycles in static and dynamic conditions, in: Proceedings of the ASME Design Engineering Technical Conference, 2016. <https://doi.org/10.1115/DETC2016-59092>
- [5] Eppinger, S.; Ulrich, K.: Product design and development, McGraw-Hill Higher Education, 2015.
- [6] Kawata, K.: Development of a motorcycle frame with low stiffness in the side direction for racing, in: procedeeing of JSAE/SAE Small Engine Technologies Conference & Exhibition, 2015.
- [7] Lo Presti, I.; Cavazzoni, L.; Calacci, F.; Mantovani, S.: Optimization methodology for an automotive cross-member in composite materials, *Key Engineering Materials*, 754, 2017, 291–294. <https://doi.org/10.4028/www.scientific.net/KEM.754.291>
- [8] Otto, K.N.; Wood, K.: Product design, techniques in reverse engineering and new product development, Prentice-Hall, Upper Saddle River, New Jersey, 2001. ISSN: 10139826.
- [9] Pahl, G.; Beitz, W.: Engineering design: a systematic approach, Springer Science & Business Media, 2013.
- [10] Peng, Q.: Storytelling tools in support of user experience design, In: Proceedings of the 2017 CHI Conference Extended Abstracts on Human Factors in Computing Systems, 316–319, ACM. <https://doi.org/10.1145/3027063.3027121>
- [11] Renzi, C.; Leali, F.; Di Angelo, L.: A review on decision-making methods in engineering design for the automotive industry, *Journal of Engineering Design* 28(2), 2017, 118–143. <https://doi.org/10.1080/09544828.2016.1274720>
- [12] Sapanaro, M.; Ghosh, S.; Sahay, C.: Motorcycle swing arm development and refinement using response optimization, In: proceedings of ASME 2015 International Mechanical Engineering Congress and Exposition (pp. V02BT02A021–V02BT02A021). American Society of Mechanical Engineers. <https://doi.org/10.1115/IMECE2015-51670>
- [13] Scappaticci, L.; Bartolini, N.; Guglielmino, E.; Risitano, G.: Structural optimization of a motorcycle chassis by pattern search algorithm. *Engineering Optimization* 49(8), 2017, 1373–1387. <https://doi.org/10.1080/0305215X.2016.1256393>
- [14] Stedmon, A. W.; Brickell, E.; Hancox, M.; Noble, J.; Rice, D: MotorcycleSim: A user-centred approach in developing a simulator for motorcycle ergonomics and rider human factors

- research, *Advances in Transportation Studies* 27, 2011, 31–48. <https://doi.org/10.4399/97888548486723>
- [15] Vogiatzis, P.; Chen, S.; Zhou, C.: An open source framework for integrated additive manufacturing and level-set-based topology optimization, *Journal of Computing and Information Science in Engineering* 17(4), 2017, 041012. <https://doi.org/10.1115/1.4037738>
- [16] Wilson, N.; Thomson, A.; Riches, P.: Can the sports design process aid the inclusive design community?, in: proceedings of International Conference on Engineering Design, Milan, 2015.
- [17] Wilson, N.; Thomson, A.; Riches, P.: Development and presentation of the first design process model for sports equipment design, *Research in Engineering Design* 28(4), 2017, 495–509.
- Debra, N. L.: *Principles of Mechanical Design*, Oxford University Press, New York, NY, 1990. <https://doi.org/10.1007/s00163-017-0257-4>